



*p*Flow

Portable Ultrasonic Flowmeter **P118i**

Gentos Measurement & Control Co., Ltd.
12/F, Block A5, Nanshan Ipark, No.1001 College Rd.
Nanshan District, Shenzhen CHINA
Tel: 86-755-26745561
Fax: 86-755-26745333
E-mail: business@gentos.com.cn

ABOUT P118i FEATURES AND CASES



P118i Portable Ultrasonic Flowmeter enables the user to do flow measurement checks at many points in a flowprocess without the need for a permanent installation.

This ultrasonic flowmeter adopts Gentos unique PICOFLY time measurement technology, which could make the resolution reach to 10 picoseconds (0.01 nanosecond). It realizes the high response and high accuracy ultrasonic measurement technology and application.

Comparing with other traditional flowmeter or ultrasonic flowmeter, it has distinctive features such as high precision, high reliability, high capability and low cost, the flowmeter features other advantages:

PICOFLY technology designed. Less hardware components, low voltage broadband pulse transmission, low consumption power. Clear, user-friendly menu selections make flowmeter simple and convenient to use. Daily, monthly and yearly totalized flow. Parallel operation of positive, negative and net flow totalizes with scale factor (span) and 7 digit display.

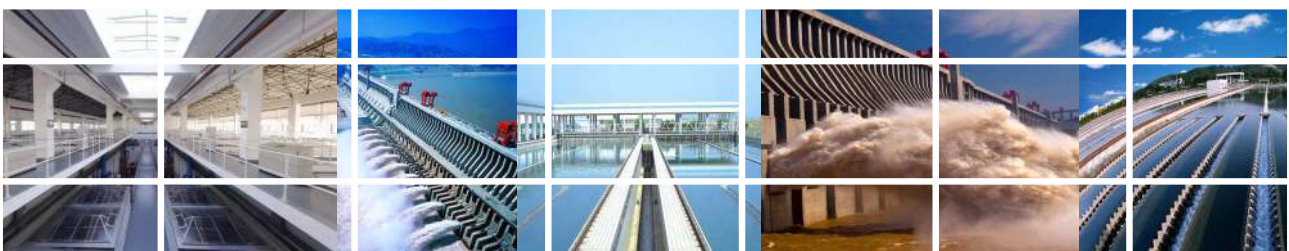

ABOUT P118i SPECIFICATION

PERFORMANCE SPECIFICATIONS

Flow range	$\pm 0.03 \sim \pm 40$ ft/s ($\pm 0.01 \sim \pm 12$ m/s)
Accuracy	$\pm 0.5\%$ of measured value
Repeatability	0.15%.
Linearity	$\pm 0.5\%$.
Pipe Size	Clamp-on: 1" ~ 240" (25mm ~ 6000mm)

FUNCTION SPECIFICATIONS

Outputs	Analog output: 4~20mA, Max 750 Ω .
SD card	Storage: 8GB; Max: 512 files; Interval: 1 ~ 60 seconds.
Power supply	rechargeable Lithium Battery Power (continuous operation of mainbattery 10 hours).
Keypad	Tactile Keys.
Display	3.5 inch TFT screen (320 x 240), backlit LCD.
Temperature	Transmitter: 14°F ~ 122°F (-10°C ~ 50°C) Transducer: 40°F ~ 176°F (-40°C ~ 80°C)
Humidity	0 to 99% RH, non-condensing

PHYSICAL SPECIFICATIONS

Transmitter	NEMA13 (IP54).
Transducer	Encapsulated design, IP68; Standard cable length: 5m.
Weight	Transmitter: approximately 1.0kg.



Suitcase



Transmitter and
Transducer



Pipe strips



Coupling compound



Card reader and
SD card

ABOUT P118i

INTERFACE AND SIZE

WIRING DIAGRAM

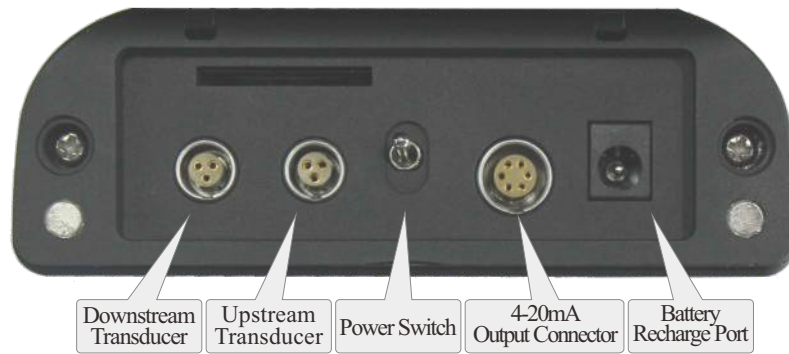

Transmitter Dimensions

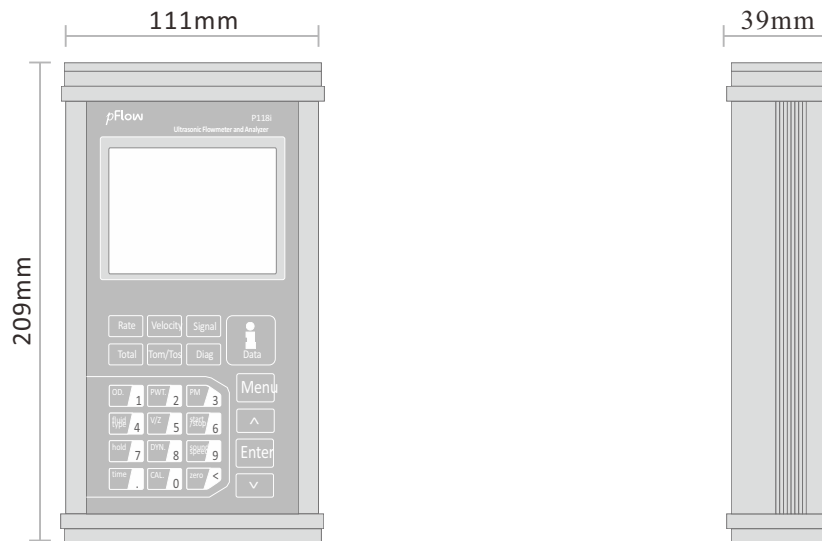

Transducer

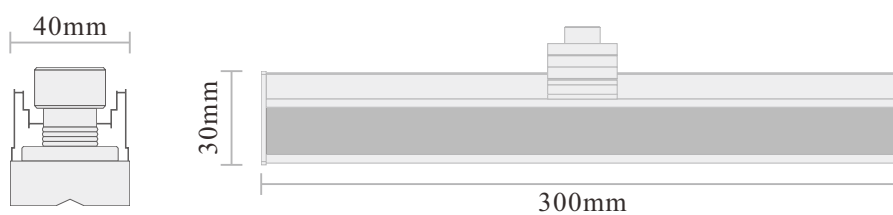

ABOUT P118i TRANSDUCER INSTALLATION METHODS

V method measuring pipe size : 50mm-400mm

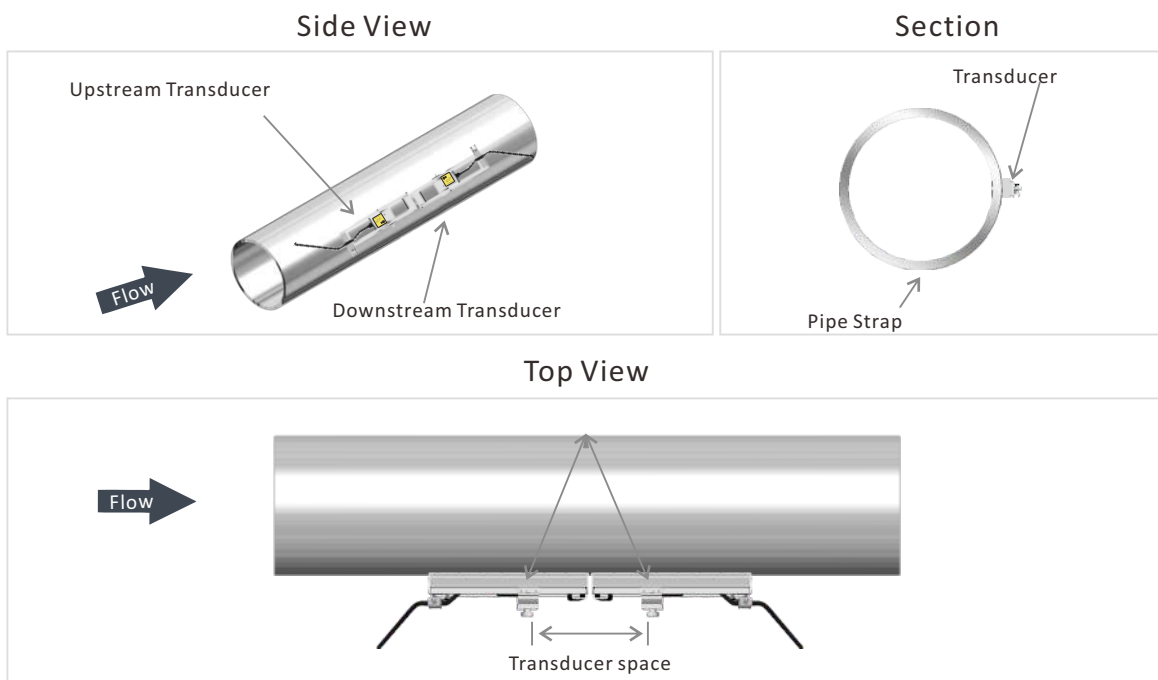

Z method measuring pipe size: 25mm-1200mm

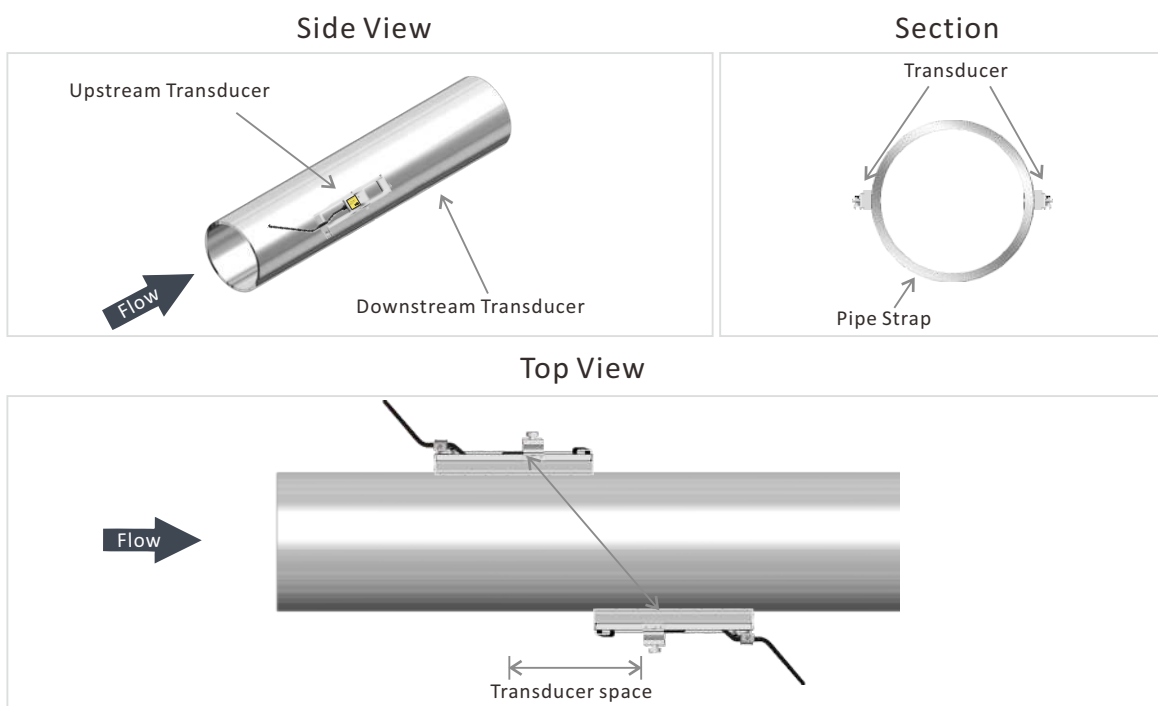

ABOUT P118i INSTALLATION SITE SELECTION

When selecting a measurement site, it is important to select an area where the fluid flow profile is fully developed to guarantee a highly accurate measurement. Use the following guidelines to select a proper installation site:

Choose a section of pipe that is always full of liquid, such as a vertical pipe with flow in the upward direction or a full horizontal pipe.

Ensure enough straight pipe length at least equal to the figure shown below for the upstream and downstream transducers installation.

Ensure that the pipe surface temperature at the measuring point is within the transducer temperature limits.

Consider the inside condition of the pipe carefully. If possible, select a section of pipe where the inside is free of excessive corrosion or scaling.

STRAIGHT LENGTH OF UPSTREAM PIPING

90° Bend

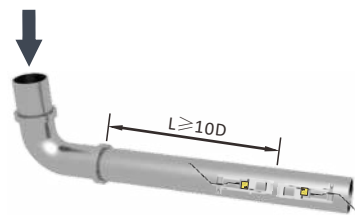

Tee

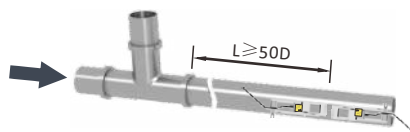

Diffuser

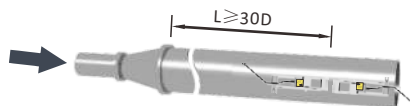

Reduce

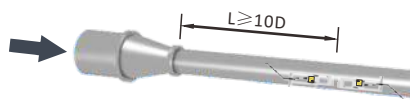

Valve

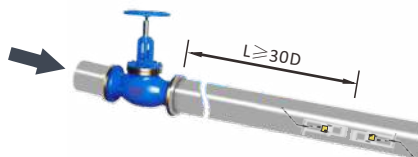

Vertical

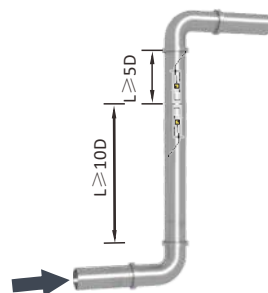

STRAIGHT LENGTH OF DOWNSTREAM PIPING

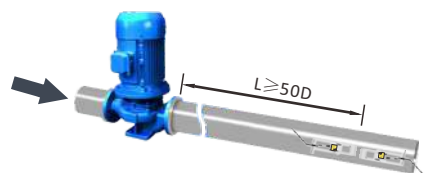
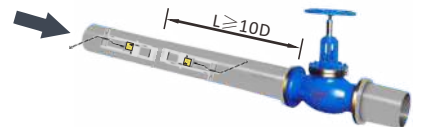
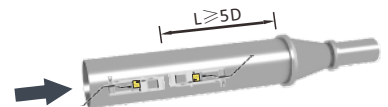
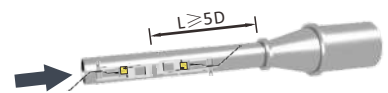
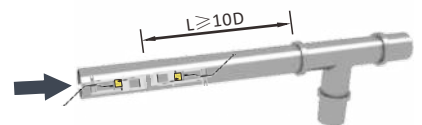
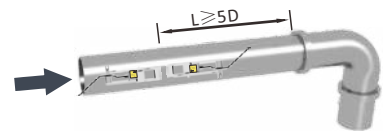

ABOUT P118i

ORDERING INFORMATION

MODEL

DESCRIPTION

P118i	<p>Portable Ultrasonic Flowmeter Installation method: Handheld 8G SD card high memory data logging, maximum memorize 512 days data. Flow Range: ± 0.03 ft/s \sim ± 40 ft/s (± 0.01 m/s \sim ± 12 m/s) Accuracy: $\pm 0.5\%$ Repeatability: 0.1% Output: 4-20mA Internal lithium power supply: 10hours Pipe size range: 0.6" \sim 48" (15mm \sim 6000mm) Transducer: IP54, CP magnet portable transducer, 5m cable</p>
-------	--

CODE

TYPE OF TRANSDUCERS

P010	<p>P type magnet portable transducer Operating temperature: $40^{\circ}\text{F} \sim 176^{\circ}\text{F}$ ($-40^{\circ}\text{C} \sim 80^{\circ}\text{C}$)</p>
PH020 (optional)	<p>PH type High temperature Clamp on transducer, 10ft (3m)cable Installation: Clamp on Outer Shell: stainless steel Measurement range: 1" \sim 48" (25mm \sim 1200mm) Temperature: $-40^{\circ}\text{F} \sim +302^{\circ}\text{F}$ ($-40^{\circ}\text{C} \sim +150^{\circ}\text{C}$)</p>

CODE

TRANSDUCER CABLE LENGTH

016	P type of cable Standard 16ft (5m)
xx	Maximum lengthen to 305m, per 5m is a lengthen unit.

Standard Model: P118i-P010-016

Description: Portable transducers, 5m cable.

Gentos Measurement & Control Co., Ltd.

12/F, Block A5. Nanshan Ipark, No.1001 College Rd.
Nanshan District. Shenzhen CHINA

Tel: 86-755-26745561

Fax: 86-755-26745333

E-mail: business@gentos.com.cn Find our website with Google search: www.pflow.com.cn