



*p*Flow

Portable Ultrasonic Flowmeter P117

Gentos Measurement & Control Co., Ltd.
12/F, Block A5, Nanshan Ipark, No.1001 College Rd.
Nanshan District, Shenzhen CHINA
Tel: 86-755-26745561
Fax: 86-755-26745333
E-mail: business@gentos.com.cn

ABOUT P117 FEATURES AND CASES



P117 Portable Ultrasonic Flowmeter enables the user to do flow measurement checks at many points in a flow process without the need for a permanent installation.

This universal transit-time meter features a dual-function push button interface, ergonomic handheld design and a beautiful 3.5in TFT backlit digital display that significantly simplifies setup and data collection.

Comparing with other traditional flowmeter or ultrasonic flowmeter, it has distinctive features such as high precision, high reliability, high capability and low cost, the flowmeter features other advantages:

TVT technology designed. Less hardware components, low voltage broadband pulse transmission, low consumption power. Clear, user-friendly menu selections make flowmeter simple and convenient to use. Daily, monthly and yearly totalized flow. Parallel operation of positive, negative and net flow totalizes with scale factor (span) and 7 digit display, while the output of totalize pulse and frequency output are transmitted via relay and open collector.

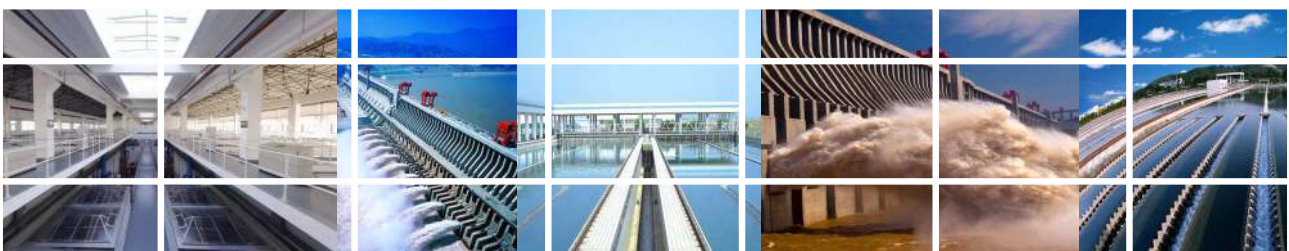

ABOUT P117 SPECIFICATION

PERFORMANCE SPECIFICATIONS

Flow range	$\pm 0.03 \sim \pm 20$ ft/s ($\pm 0.01 \sim \pm 6$ m/s)
Accuracy	$\pm 1\%$.
Repeatability	0.3%.
Linearity	$\pm 1\%$.
Pipe Size	Clamp-on: 1" ~ 48" in (25mm ~ 1200mm)

FUNCTION SPECIFICATIONS

Outputs	Analog output: 4~20mA, Max 750 Ω .
SD card	Storage: 8GB; Max: 512 files; Interval: 1 ~ 60 seconds.
Power supply	rechargeable Lithium Battery Power (continuous operation of mainbattery 10 hours).
Keypad	Tactile Keys.
Display	3.5 inch TFT screen (320 x 240), backlit LCD.
Temperature	Transmitter: 14°F ~ 122°F (-10°C ~ 50°C) Transducer: 40°F ~ 176°F (-40°C ~ 80°C)
Humidity	0 to 99% RH, non-condensing

PHYSICAL SPECIFICATIONS

Transmitter	NEMA13 (IP54).
Transducer	Encapsulated design, IP68; Standard cable length: 5m.
Weight	Transmitter: approximately 1.0kg.



Suitcase



Transmitter and
Transducer



Pipe strips



Coupling compound



Card reader and
SD card

ABOUT P117

INTERFACE AND SIZE

WIRING DIAGRAM

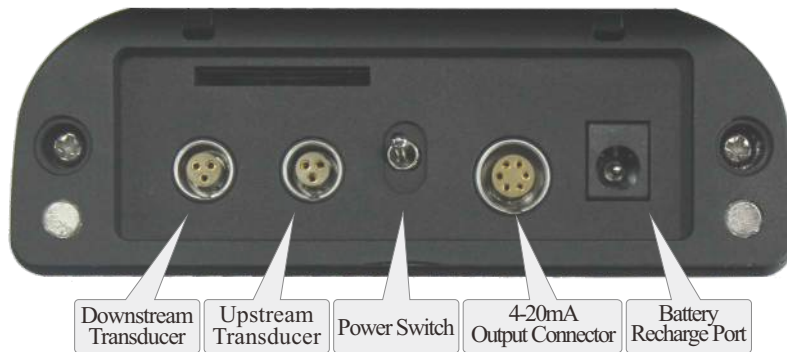

TRANSMITTER DIMENSIONS

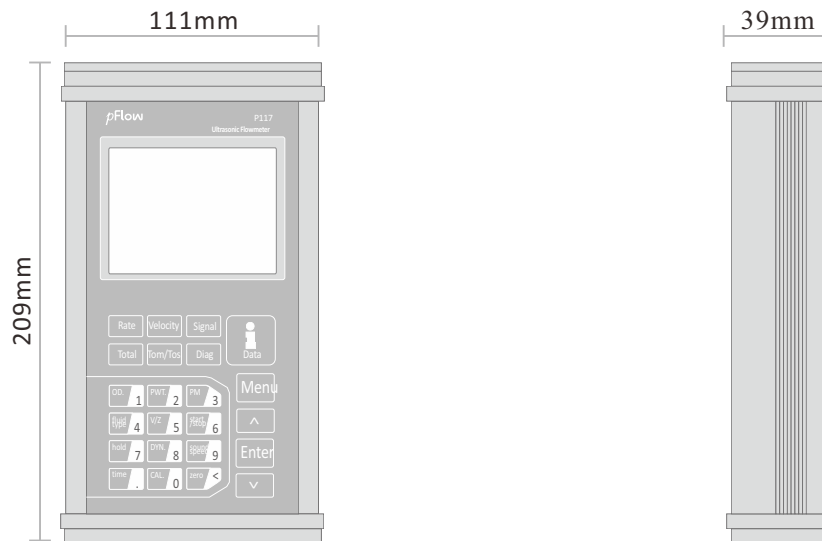

TRANSDUCER

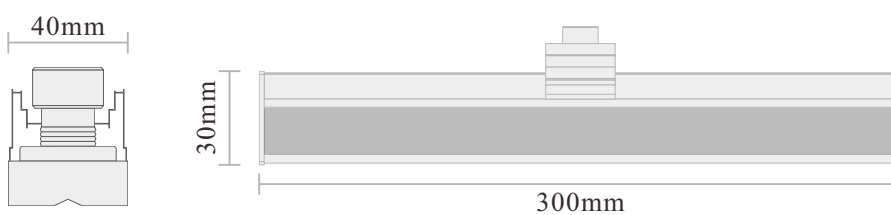

ABOUT P117 TRANSDUCER INSTALLATION METHODS

V method measuring pipe size : 50mm-400mm

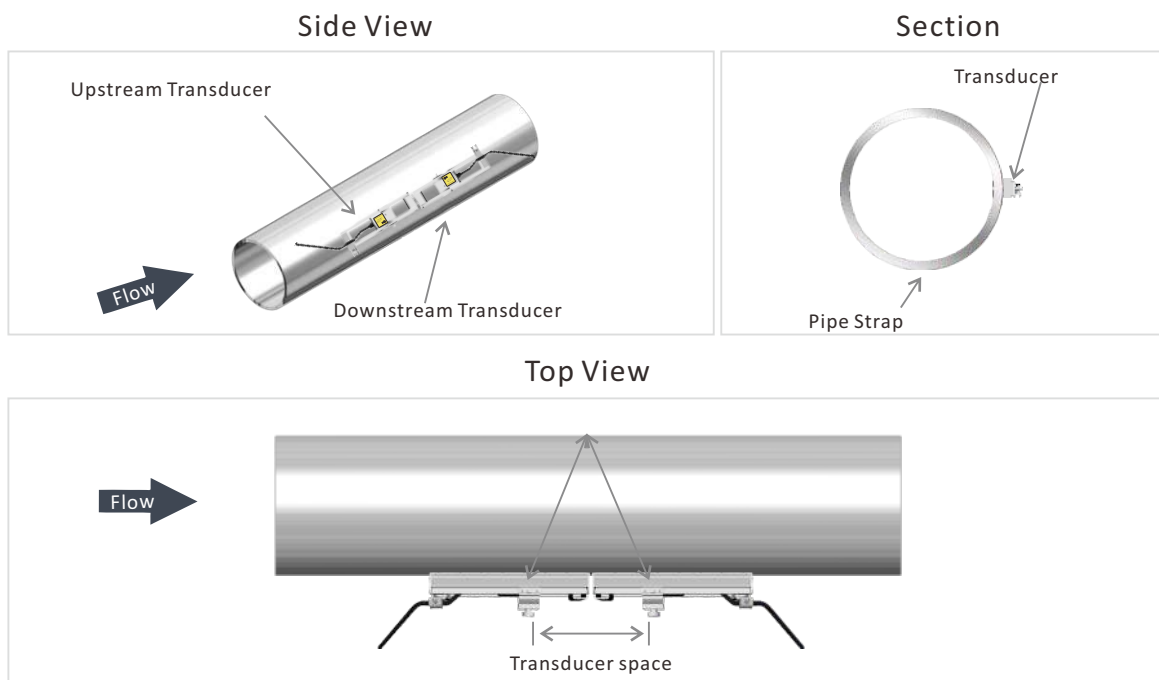

Z method measuring pipe size: 25mm-1200mm

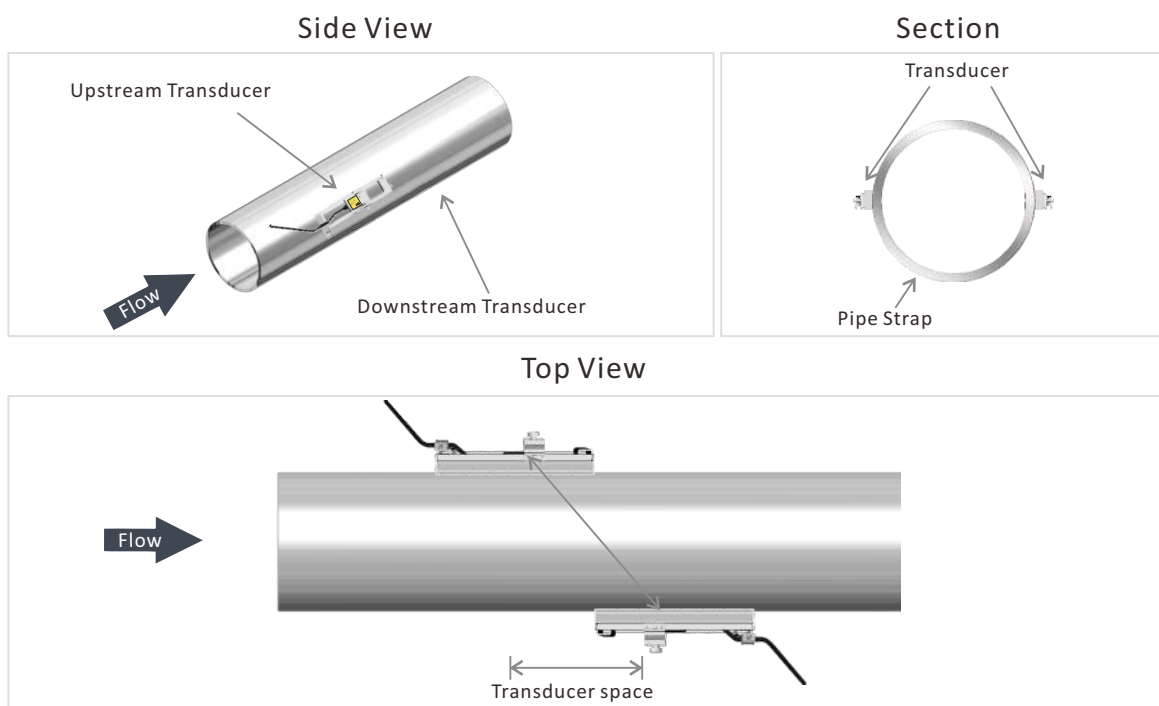

ABOUT P117 INSTALLATION SITE SELECTION

When selecting a measurement site, it is important to select an area where the fluid flow profile is fully developed to guarantee a highly accurate measurement. Use the following guidelines to select a proper installation site:

Choose a section of pipe that is always full of liquid, such as a vertical pipe with flow in the upward direction or a full horizontal pipe.

Ensure enough straight pipe length at least equal to the figure shown below for the upstream and downstream transducers installation.

Ensure that the pipe surface temperature at the measuring point is within the transducer temperature limits.

Consider the inside condition of the pipe carefully. If possible, select a section of pipe where the inside is free of excessive corrosion or scaling.

STRAIGHT LENGTH OF UPSTREAM PIPING

90° Bend

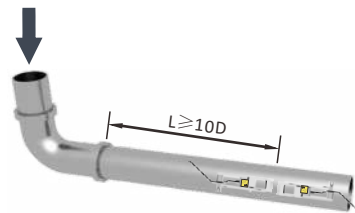

Tee

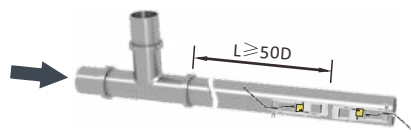

Diffuser

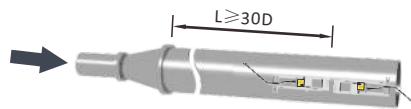

Reduce

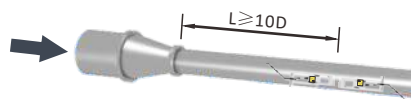

Valve

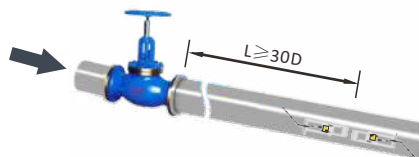

Vertical

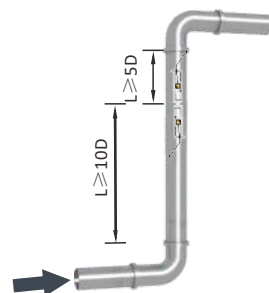

STRAIGHT LENGTH OF DOWNSTREAM PIPING

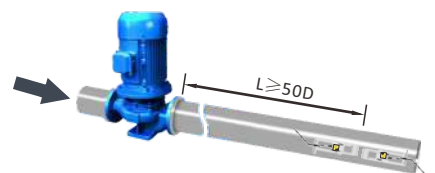
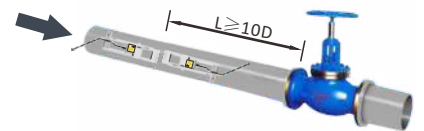
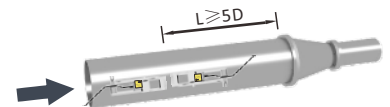
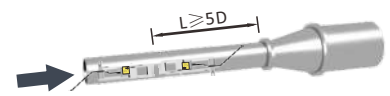
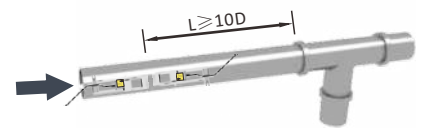
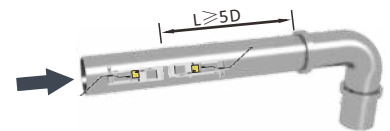

ABOUT P117

ORDERING INFORMATION

MODEL

DESCRIPTION

P117	<p>Portable Ultrasonic Flowmeter Installation method: Handheld 8G SD card high memory data logging, maximum memorize 512 days data. Flow Range: ± 0.03 ft/s \sim ± 20 ft/s (± 0.01 m/s \sim ± 6 m/s) Accuracy: $\pm 1\%$ Repeatability: 0.3% Output: 4-20mA Internal lithium power supply: 10hours Pipe size range: 1"~48" (25mm~1200mm) Transducer: IP54, CP magnet portable transducer, 5m cable</p>
------	---

CODE

TYPE OF TRANSDUCERS

P011	<p>P type magnet portable transducer Operating temperature: $40^{\circ}\text{F} \sim 176^{\circ}\text{F}$ ($-40^{\circ}\text{C} \sim 80^{\circ}\text{C}$)</p>
------	--

CODE

TRANSDUCER CABLE LENGTH

016	P type of cable Standard 16ft (5m)
xx	Maximum lengthen to 305m, per 5m is a lengthen unit.

Standard Model: P117-P011-016

Description: Portable transducers, 5m cable.

Gentos Measurement & Control Co., Ltd.

12/F, Block A5. Nanshan Ipark, No.1001 College Rd.
Nanshan District. Shenzhen CHINA

Tel: 86-755-26745561

Fax: 86-755-26745333

E-mail: business@gentos.com.cn Find our website with Google search: www.pflow.com.cn